

TOX®-ElectricPowerDrive Type EXe-K

Data sheet 40.55
2022/08



TOX[®]-ElectricPowerDrive servo drive

Type EXe-K, 10 – 200 kN with planetary roller screw

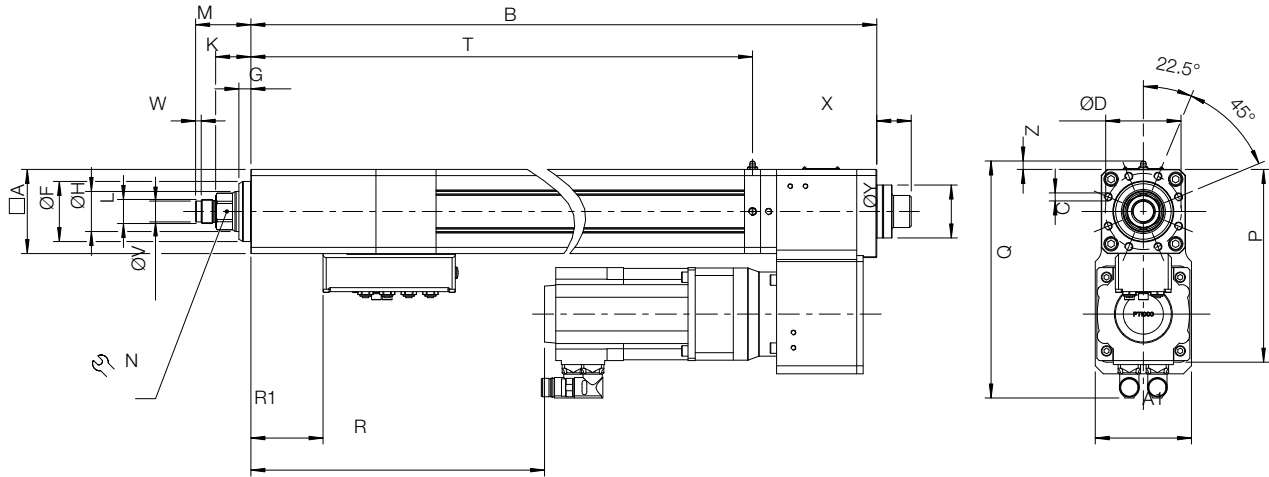

Dimensions and weights

Preferred series (short delivery time)

Type	Stroke length mm	Max. nominal force kN	Weight approx. kg
EXe-K 010.XXX.150	150	10	24
EXe-K 010.XXX.300	300	10	25
EXe-K 030.XXX.150	150	30	41
EXe-K 030.XXX.300	300	30	43
EXe-K 030.XXX.450	450	30	45
EXe-K 060.XXX.150	150	60	68
EXe-K 060.XXX.300	300	60	72
EXe-K 060.XXX.450	450	60	76
EXe-K 100.XXX.150	150	100	106
EXe-K 100.XXX.300	300	100	111
EXe-K 100.XXX.450	450	100	116
EXe-K 200.XXX.150	150	200	178
EXe-K 200.XXX.300	300	200	187
EXe-K 200.XXX.450	450	200	196

Type	A	A1	B	C	D	F _T	G	H	K ¹⁾	L	M ¹⁾	N	P	Q	R	R1	T	V _{ge}	W	X	Y	Z
EXe-K 010.XXX.150	70	90	606	8x M6x12	60	50	10	30	28	M12x1.5	40	27	165	220	202	12	497	-	-	33	42	10
EXe-K 010.XXX.300	70	90	756	8x M6x12	60	50	10	30	28	M12x1.5	40	27	165	220	352	12	647	-	-	33	42	10
EXe-K 030.XXX.150	90	110	703	8x M8x16	80	65	10	40	26	M22x2	46	36	208	258	247	53	585	18	7	35	52	10
EXe-K 030.XXX.300	90	110	853	8x M8x16	80	65	10	40	26	M22x2	46	36	208	258	397	53	735	18	7	35	52	10
EXe-K 030.XXX.450	90	110	1003	8x M8x16	80	65	10	40	26	M22x2	46	36	208	258	547	53	885	18	7	35	52	10
EXe-K 060.XXX.150	105	135	817	8x M10x20	95	75	15	50	44	M30x2	69	41	248	296	323	90	662	26	7	43	66	10
EXe-K 060.XXX.300	105	135	967	8x M10x20	95	75	15	50	44	M30x2	69	41	248	296	473	90	812	26	7	43	66	10
EXe-K 060.XXX.450	105	135	1117	8x M10x20	95	75	15	50	44	M30x2	69	41	248	296	623	90	962	26	7	43	66	10
EXe-K 100.XXX.150	130	160	875	8x M12x24	115	90	17	60	42	M30x2	67	55	295	348	343	115	702	26	7	46	75	10
EXe-K 100.XXX.300	130	160	1025	8x M12x24	115	90	17	60	42	M30x2	67	55	295	348	493	115	852	26	7	46	75	10
EXe-K 100.XXX.450	130	160	1175	8x M12x24	115	90	17	60	42	M30x2	67	55	295	348	643	115	1002	26	7	46	75	10
EXe-K 200.XXX.150	160	160	1000	8x M16x32	135	105	17	75	42	M39x2	77	65	345	379	372	155	789	-	-	58	90	10
EXe-K 200.XXX.300	160	160	1150	8x M16x32	135	105	17	75	42	M39x2	77	65	345	379	522	155	939	-	-	58	90	10
EXe-K 200.XXX.450	160	160	1300	8x M16x32	135	105	17	75	42	M39x2	77	65	345	379	672	155	1089	-	-	58	90	10

¹⁾ Dimension refers to zero position of drive. Reference position = zero position - 3 mm.

Dimensions in mm

Specifications EXe-K	010	030	060	100	200
Mechanical					
Nominal pressing force	10 kN	30 kN	60 kN	100 kN	200 kN
Nominal pulling force	3 kN	8 kN	17 kN	30 kN	60 kN
Max. speed	300 mm/s	280 mm/s	250 mm/s	200 mm/s	120 mm/s
Repeatability ¹⁾	0,01 mm				
Max. tool weight without brake ⁴⁾	10 kg	15 kg	25 kg	50 kg	100 kg
with safety brake / motor holding brake ⁵⁾	25 kg	125 kg	300 kg	500 kg	1000 kg
Sensors					
Force transducer measuring range ²⁾	0.1 – 10 kN	0.3 – 30 kN	0.6 – 60 kN	1 – 100 kN	2 – 200 kN
Accuracy	≤ ± 0,5% of nominal pressing force				
Resolver	■	■	■	■	■
Resolution (theoretically)	0.00198 mm	0.00185 mm	0.00185 mm	0.00185 mm	0.00106 mm
Electrical					
Protection class ³⁾	IP 54				
Mains supply	see data sheet 40.15 System & Components				
Climatic conditions	+ 10° to + 40° C, from 40° C performance loss, max. 55° C; air moisture < 75 %, without condensation				

¹⁾ In thermal transient condition

²⁾ Recommended operating range 1 – 100 %

³⁾ Optional: Protection class IP 65

⁴⁾ For higher weights, the tool can sink in de-energized condition

⁵⁾ Higher tool weights on request

Ordering example

EXe-K 010.XXX.300

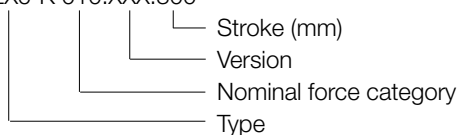

A wide range of accessories is available for the servo drive type EXe-K (see data sheet 40.95, TOX®-ElectricPowerDrive Accessories).

Version

- 003 Basic version
- 004 Safety brake
- 005 Safety brake with rotary encoder
- 006 Motor holding brake
- 007 Includes holding time min 10s at min. 80% of nominal pressing force
- 008 Includes safety brake and holding time min. 10s at min. 80% of nominal pressing force
- 011 Includes identical nominal pressing/pulling force, punching
- 012 Includes safety brake and identical nominal pressing/pulling force, punching
- 053 Includes protection class IP65
- 054 Includes safety brake and protection class IP65
- 302 Includes working piston with threaded holes on piston end
- 303 Includes safety brake and working piston with threaded holes on piston end

Further versions are available upon request!

TOX[®]-EdgeUnit

TOX[®]-EdgeUnit is the decentralized intelligence for each TOX[®]-ElectricPowerDrive

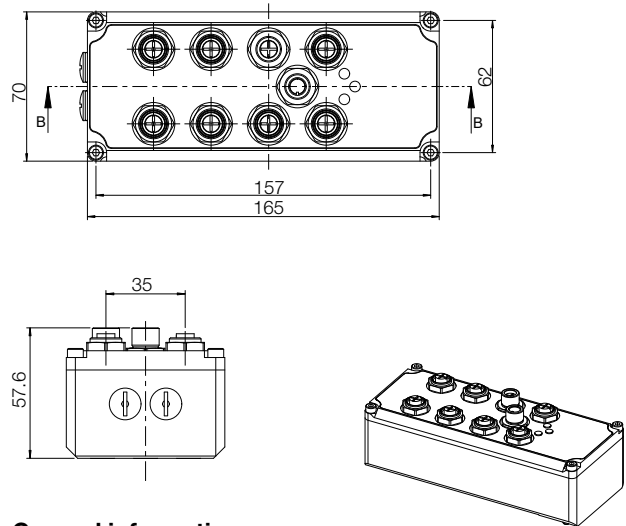
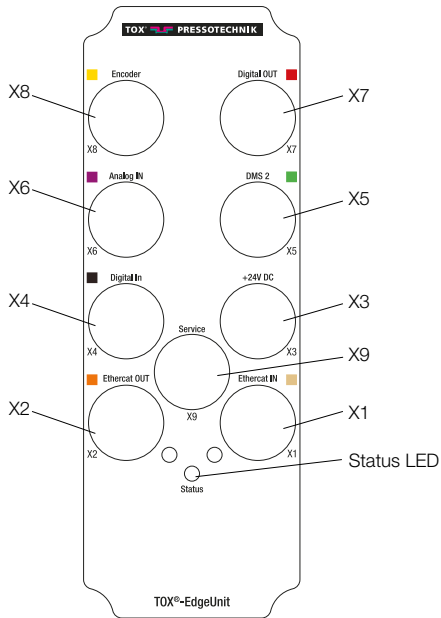

General information:

- Ambient temperature: 0 ... 50°C
- IP protection: IP 65 (plug closed)
- Housing: aluminum
- Status LED shows different states of the TOX[®]-EdgeUnit
- Integrated memory

Technical data/interfaces

X1 ■	Ethercat IN, incl. status LED
Pin assignment	M12 4-pin Bushing, D-coded
X2 ■	Ethercat OUT, incl. status LED
Pin assignment	M12 4-pin Bushing, D-coded
X3	Power supply
Voltage	+ 24VDC (18 ... 28 VDC)
Current draw	< 0.25 A (without outputs on X7)
US1 and US2	Power supply Logic voltage / driving voltage
Pin assignment	M12 5-pin, plug A-coded
X4 ■	Digital IN
Digital IN 1 / Digital IN 2	24VDC
Logic level 0 (LOW)	0V ... 10V
Logic level 1 (HIGH)	16V ... 28V
Input current	max. 2 mA (at 24V)
Pin assignment	M12 5-pin bushing, A-coded
X5 ■	DMS 2
Measuring range	1.157 mV/V – 3,25 mV/V (intensifier adjustable)
Voltage VDC	5V
Shunt resistor	typ. 700 Ω
Resolution	16 Bit
Pin assignment	M12 5-pin bushing, A-coded

X6 ■	Analog IN
Analog IN 1	-10 ... 10VDC, 16 bit
Analog IN 2	0 ... 10VDC, 12 bit
Pin assignment	M12 5-pin bushing, A-coded
X7 ■	Digital OUT
Digital OUT 0 / Digital OUT 1	24VDC, US2
Output current	max. 2 A (per channel) / overcurrent and short-circuit proof
Pin assignment	M12 5-pin bushing, A-coded
X8 ■	Encoder
Pin assignment	M12 8-pin bushing, A-coded
X9	Service pin
Pin assignment	M12 8-pin Plug, A-coded

M12 pin assignment

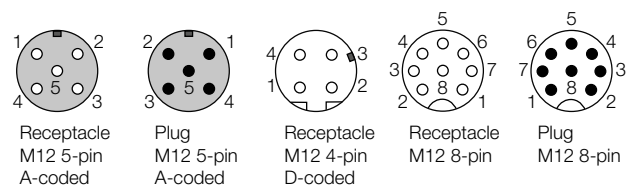

Pin assignments

EdgeUnit

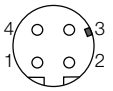
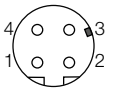
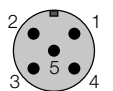
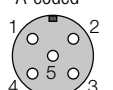
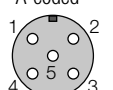
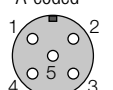
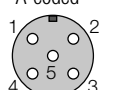
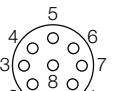
Version	Designation	Description
X1 Receptacle 4-pin, D-coded 	EtherCat In	Pin 1 = TD+ Pin 2 = RD+ Pin 3 = TD- Pin 4 = RD-
X2 	EtherCat Out	Pin 1 = TD+ Pin 2 = RD+ Pin 3 = TD- Pin 4 = RD-
X3 Plug 5-pin, A-coded 	Power	Pin 1 = 24V US2 Pin 2 = GND US2 Pin 3 = 24V US1 Pin 4 = GND US1 Pin 5 = PE
X4 Receptacle 5-pin, A-coded 	Digital In	Pin 1 = 24V Pin 2 = DIN2 24V Pin 3 = GND Pin 4 = DIN1 24V Pin 5 = PE
X5 	DMS 2	Pin 1 = DMS Sig (neg) Pin 2 = 5V DMS Ref Pin 3 = GND Ref DMS Pin 4 = DMS Sig (pos) Pin 5 = -
X6 	Analog In	Pin 1 = 24V Pin 2 = AIN2 0 ... 10V Pin 3 = GND Pin 4 = AIN1 -10 ... 10V Pin 5 = PE
X7 	Digital Out	Pin 1 = 24V Pin 2 = DOUT1 24V US2 (2A) Pin 3 = GND Pin 4 = DOUT0 24V US2 (2A) Pin 5 = PE
X8 Receptacle 8-pin 	Encoder	Pin 1 = 5V Pin 2 = APR Pin 3 = ANR Pin 4 = BPR Pin 5 = BNR Pin 6 = CPR Pin 7 = CNR Pin 8 = GND

Safety brake (optional)

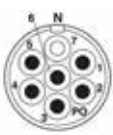
Pin	Designation	Description	Plug
1	24V	Release brake V+	
2	0V	Release brake V-	
3	24V	Sensor V+	
4	0V	Sensor V-	
5	S + 24V	Sensor signal release brake	
6	N.C.		
7	N.C.		

Type: Intercontec ASDA157FR12580150400, 7-pin

Motor/Motor holding brake (optional)

For TOX®-ElectricPowerDrive EXe-K 010, 030, 060

Pin	Designation	Description	Plug
1	BD1	Immobilisation brake DC +/AC	
2	BD2	Immobilisation brake DC -/AC	
PE	PE	Protective conductor	
4	U	Power leg U	
5	V	Power leg V	
6	W	Power leg W	

Type: Intercontec ICN-M23, 6-pin

For TOX®-ElectricPowerDrive EXe-K 100, 200

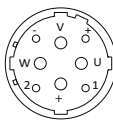
Pin	Designation	Description	Plug
U	U	Power leg U	
+	BD1	Immobilisation brake +	
-	BD1	Immobilisation brake -	
W	W	Power leg W	
V	V	Power leg V	
PE	PE	Protective conductor	
1		Not occupied	
2		Not occupied	

Type: Intercontec ICN-M40, 8-pin

Resolver

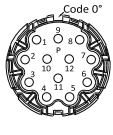
Pin	Designation	Description	Plug
1	+Ref	Transformer windings	
2	-Ref		
3	+VCC ETS	Not assigned	
4	+COS	Stator winding Cosinus	
5	-COS		
6	+SIN	Stator windings Sinus	
7	-SIN		
8		Not assigned	
9			
10	Shield	Housing shield of transmitter	
11	+	Temperature monitoring: PT1000	
12	-		

Type: Intercontec ICN-M23, 12-pin

Lifetime L10

The lifetime L10 is a complex calculation. The following factors influence the lifetime L10, in some cases considerably:

- Rate of force application
- Powerstroke
- Punching impact
- Application
- Revolutions per minute

Schematic illustration of the lifetime L10

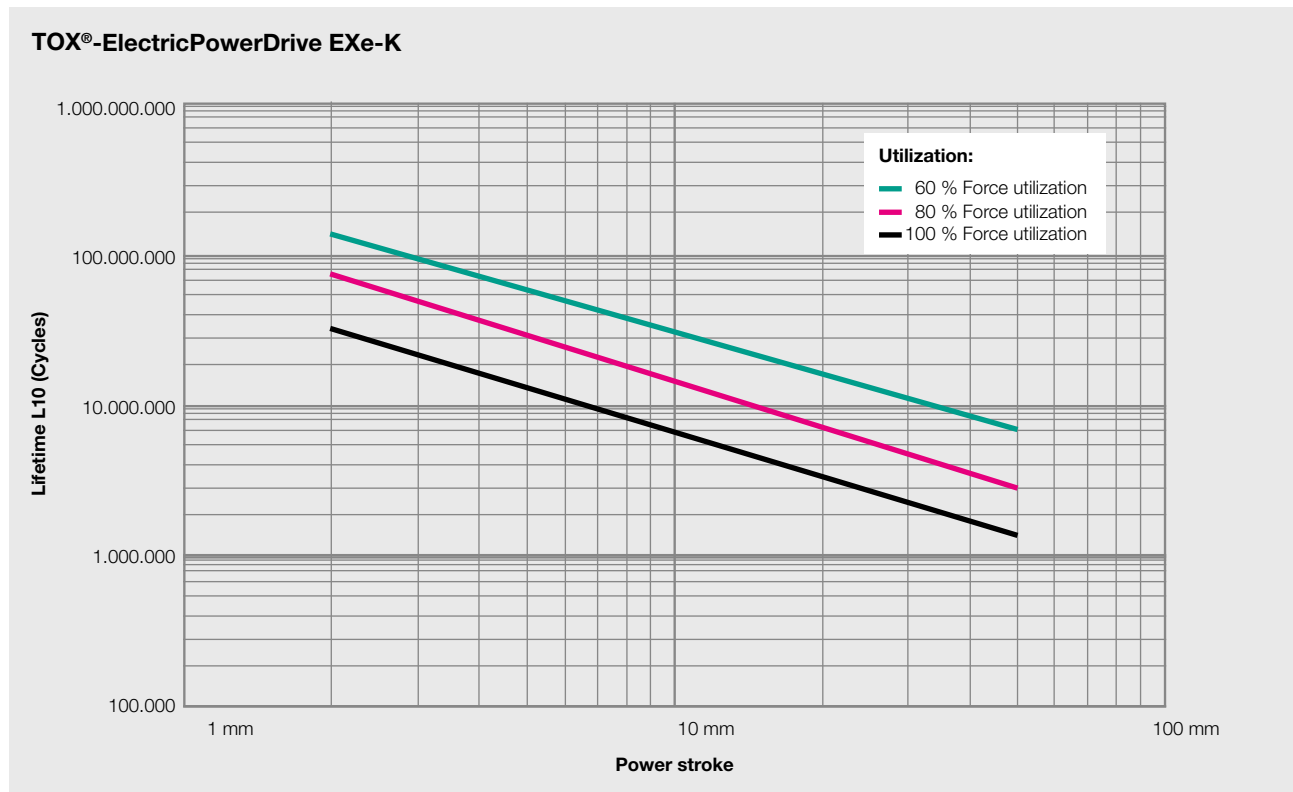

We are happy to carry out the lifetime calculation for your application. Just ask us!